

Electro-pneumatic Regulator Integrated Type 64-station Compatible Manifold

New



Plug-in Compact 5-Port Solenoid Valve

Solenoid valves and electro-pneumatic regulators can be connected to the same manifold.

Valve stations/Number of outputs: For 4 to 64 stations*1/128 points

*1 Stations are only available in multiples of 4.

Electro-pneumatic regulator stations: 1 to 4 stations

I/O unit stations: Max. 8 stations



Compatible protocol: **PROFINET** EtherNet/IP EtherCAT

Reduced wiring **Reduced number of SI units** **Reduced wiring work** **Compact**

Approx. 348 mm

(JSY3000-P: Manifold with 4 electro-pneumatic regulator stations and 4 solenoid valve stations)

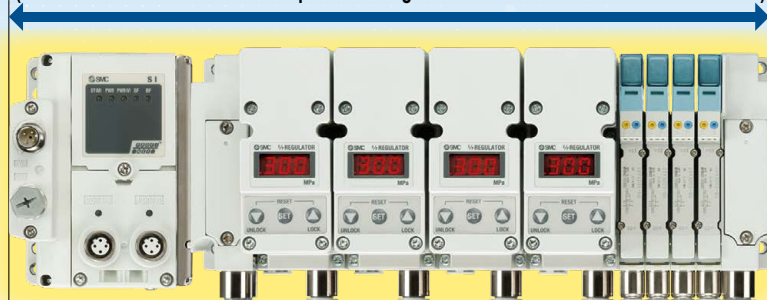

134 mm shorter
(28% reduction)

Number of SI units **1 set**

Power supply cable **1 cable**

Communication cable **1 cable**

Approx. 300 mm

(4-station electro-pneumatic regulator manifold)



Approx. 182 mm

(4-station solenoid valve manifold)



Number of SI units **2 sets**

Power supply cable **2 cables**

Communication cable **2 cables**

JSY3000-P Series



CAT.ES11-120A

Equipment integration allows for the centralized management

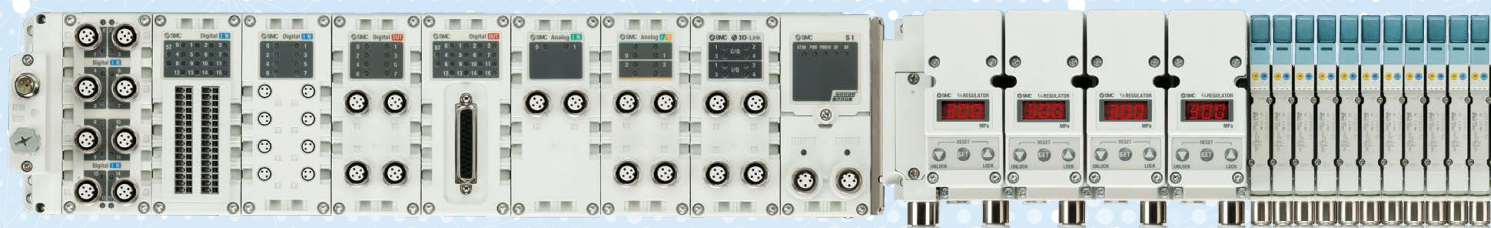

Fieldbus communication

(I/O unit zone)
 Max. 8 stations

Pressure control

(Electro-pneumatic regulator zone)
 Max. 4 stations

For the electro-pneumatic regulators, select from **1** individual output of regulated air and **2** solenoid valve supply pressure control



Electro-Pneumatic Regulator

For the stepless control of air pressure in proportion to electrical signals

Fieldbus System

Compatible protocol



EtherNet/IP

EtherCAT

Connector connection
 requires no wiring.

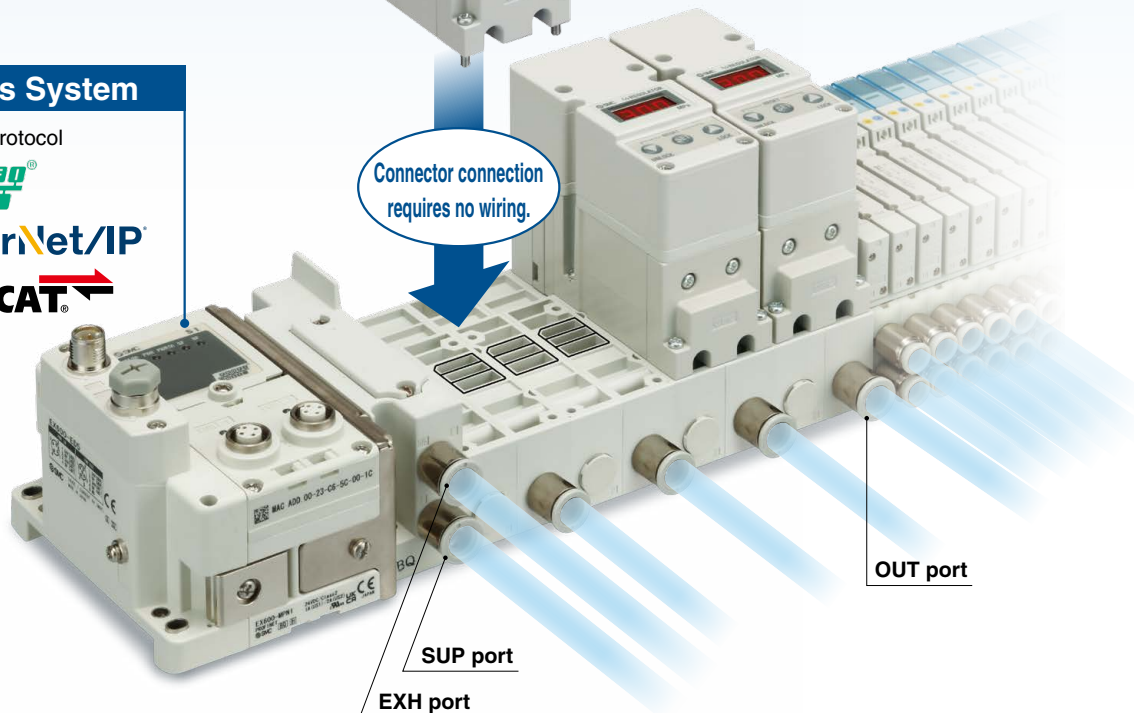

of control and wiring as well as reduced wiring



Drive control

(JSY3000 Solenoid valve zone)
 Max. 64 stations

■ When ① individual output of regulated air (direct output type) is selected for the electro-pneumatic regulators

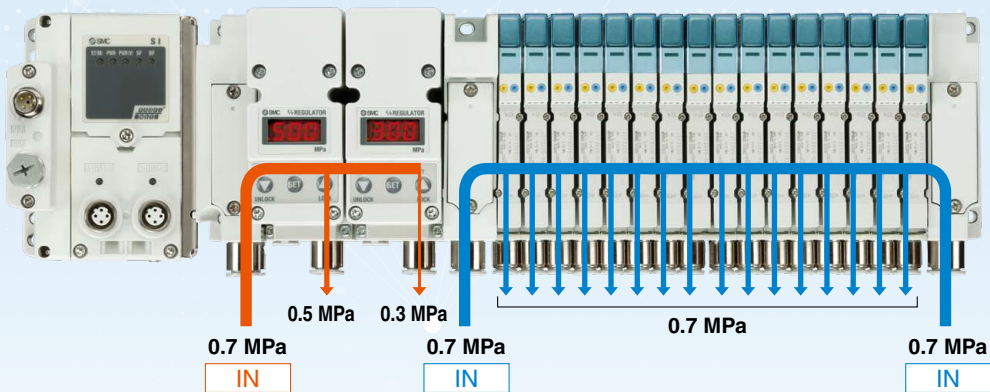

■ When ② solenoid valve supply pressure control (valve supply type) is selected for the electro-pneumatic regulators

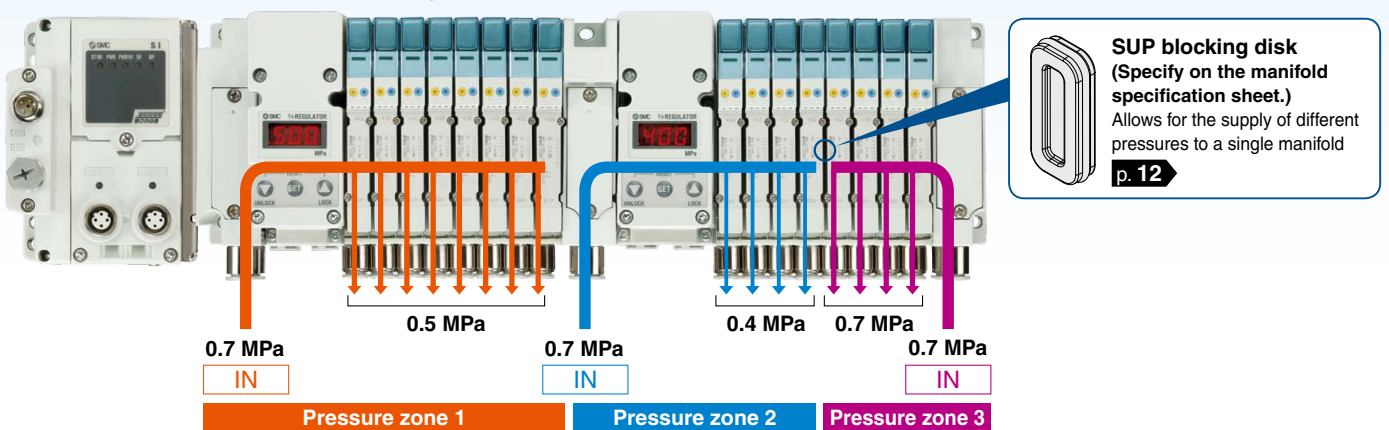

CONTENTS

Electro-pneumatic Regulator Integrated Type 64-station Compatible Manifold **Plug-in** Compact 5-Port Solenoid Valve *JSY3000-P Series*

Plug-in Connector Connecting Base		How to Order Valves (With mounting screw)	p. 7
Manifold Specifications	p. 3	How to Order Electro-Pneumatic Regulators for Manifold (With mounting screw)	p. 8
Manifold Flow Rate Characteristics	p. 3	Dimensions	p. 9
Electro-Pneumatic Regulator for Manifold	p. 4	Fieldbus System for Manifold	p. 10
How to Order Manifolds	p. 6	Manifold Options	p. 13
How to Order Manifold Assembly	p. 7		

Plug-in Connector Connecting Base

Manifold Specifications

Wiring	Serial wiring EX600 for 64-station compatible manifold	
Manifold type	Plug-in connector connecting base (64-station compatible manifold)	
SUP/EXH port type	Common SUP/EXH (Common for the 3/5 port)	
Valve stations	4 to 64 stations	
Applicable connector	—	
Internal wiring	Negative common	
Port size	1(P), 3/5(E) port	ø10 One-touch fitting
	4(A), 2(B) port	ø4/ø6/ø8 One-touch fitting
Enclosure (Based on IEC 60529)	IP65	

Formula for 64-station Compatible Manifold Weight*2 (Unit: g)

$$W = 47 \times n1 + 852 + 138 \times n2 + 535 \times n3 + 676 \times n4$$

n1: Number of valve stations*1

n2: Number of intermediate SUP/EXH blocks

n3: Number of electro-pneumatic regulators, ITV2340-□A

n4: Number of electro-pneumatic regulators, ITV2340-□(M, S)

*1 Stations are only available in multiples of 4, from 4 stations to 64 stations.

*2 Weight: "W" is the value for the internal pilot specification, the max. fitting size, and the manifold only. The valve weight is not included. To obtain the weight with valves mounted, add the valve weight given in the **Web Catalog** for the appropriate number of stations.

Manifold Flow Rate Characteristics

Model	Port size		Valve flow rate characteristics			
	1, 3/5 (P, E)	4, 2 (A, B)	1 → 4/2 (P → A/B)		4/2 → 3/5 (A/B → E)	
			C [dm ³ /(s·bar)]	b	C [dm ³ /(s·bar)]	b
JJ5SY3-P10 (Side ported)	C10	C8	2.23	0.30	2.77	0.27

* Calculation of effective area "S" and sonic conductance "C": S = 5.0 x C

* Values measured in accordance with ISO 6358:1989, JIS B 8390:2000

⚠ Caution

Securing the DIN Rail Mounting Type Manifold

1. When mounting the manifold to a DIN rail using bolts, be sure that the bottom surface of the DIN rail is in contact with the manifold installation surface (in a horizontal state), then secure both ends of the DIN rail with the bolts. However, for other mounting methods or for side facing or upside down orientations, use the formula below to calculate the number of bolts to use at even intervals along the DIN rail.

Formula: Number of bolts = DIN rail length/75 (Round up to the nearest whole number)

Example) When the DIN rail length is 1123 mm, secure in 15 locations as a guide.

2. When using the manifold with a DIN rail in an environment where any vibration or impact is applied to it, the DIN rail itself may break. In particular, if the installation surface vibrates when mounting the manifold on the wall, or if a load is directly applied to the manifold, the DIN rail may break, causing the manifold to drop. When any vibration, impact, or load will be applied to the manifold, be sure to use a direct mounting manifold.

Valve supply type

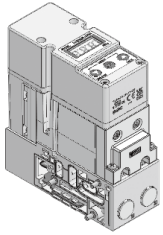

ITV2340-1□A

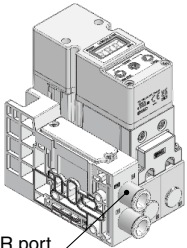

R port

ITV2340-1□M-□

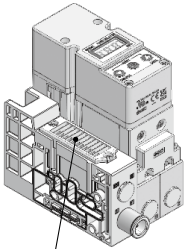

Silencer

ITV2340-1□S-□

Direct output type

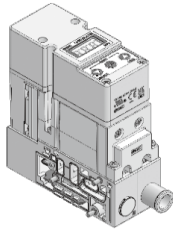

ITV2340-2□A

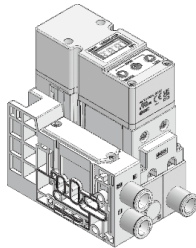

ITV2340-2□M-□

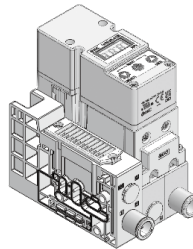

ITV2340-2□S-□

Specifications

Electro-Pneumatic Regulator*¹

Fluid		Air		
Pressure display unit	MPa	bar	psi	
Min. supply pressure	Set pressure + 0.05 MPa	Set pressure + 0.5 bar	Set pressure + 7.25 psi	
Max. supply pressure	1.0 MPa	10 bar	145 psi	
Set pressure range (Rated)*²	0 to 0.7 MPa	0 to 7 bar	0 to 100 psi	
Min. set pressure	0.005 MPa	0.05 bar	1 psi	
Power supply	Voltage	24 VDC ±10% (Stabilized power supply with a ripple rate of 1% or less)		
	Current consumption	0.12 A or less		
Linearity*³	±0.009 MPa or less	±0.09 bar or less	±1.3 psi or less	
Hysteresis*³	0.0045 MPa or less	0.045 bar or less	0.65 psi or less	
Repeatability*³	±0.0045 MPa or less	±0.045 bar or less	±0.65 psi or less	
Sensitivity	±0.2% F.S. (Input signal variation: 8/4095 (12 bit) or more)			
Temperature characteristics	±0.00108 MPa/°C or less	±0.0108 bar/°C or less	±0.156 psi/°C or less	
Step response*⁴	0.3 s or less			
Output pressure display*⁵	Display type	3-digit, 7-segment LED, 1-color display (Red)		
	Accuracy	±0.018 MPa ±1 digit or less	±0.18 bar ±1 digit or less	±3 psi ±1 digit or less
	Min. unit	0.001 (Actual display: .001)	0.01	1
Ambient and fluid temperatures	0 to 50°C (No condensation)			
Enclosure	IP65			
Weight	ITV2340-□□A: 535 g (Without tie-rod) ITV2340-□□ (M, S): 676 g (Without tie-rod)			

*1 This specification table shows the characteristics at a power supply voltage of 24 VDC, ambient temperature of 25 ±3°C, and no load applied.

Only in static conditions, the pressure may fluctuate when air is consumed on the output side.

*2 When the input signal is 0%, there is residual pressure equal to or less than the minimum set pressure.

In cases where the pressure needs to be reduced completely to 0, install a 3-port valve, etc., on the output side to discharge the residual pressure.

*3 Compliant with ISO 10094

*4 This is the characteristics to reach 90% of the set pressure when the step amount are [0 → 100%], [25 → 75%], and [45 → 55%] under the max. supply pressure conditions.

*5 The zero/span adjustment values are set by the minimum unit of the output pressure display. Note that the unit cannot be changed.

JSY3000-P Series

JSY3000-P:ITV Series

Compliant with ISO 10094

Linearity

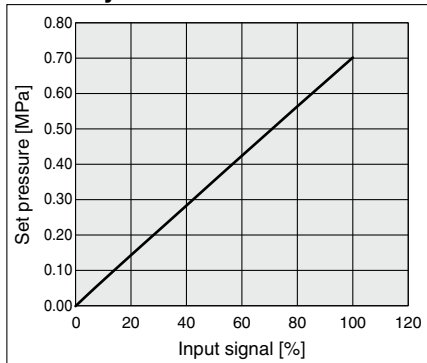

Hysteresis

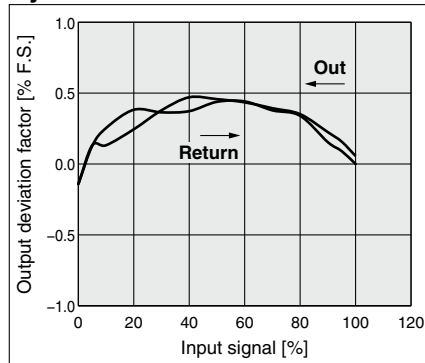

Repeatability

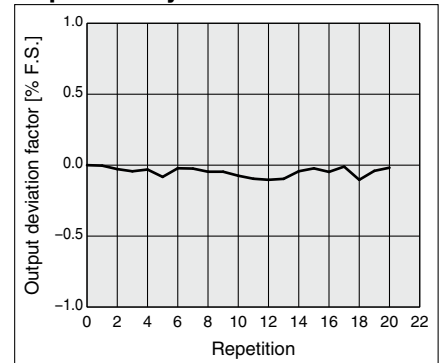

Pressure Characteristics

Set pressure: 0.28 MPa

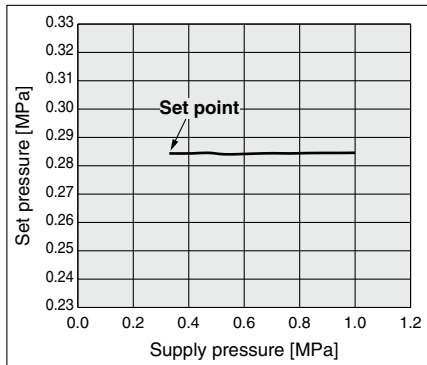

Flow Rate Characteristics

Supply pressure: 1.0 MPa

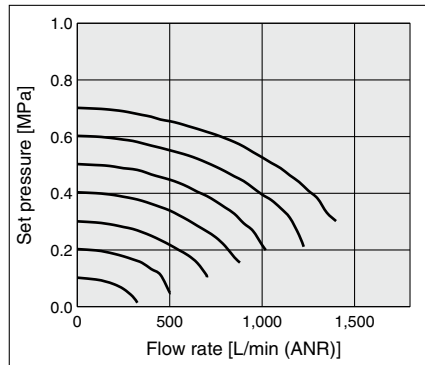

Relief Characteristics

Back pressure: 1.0 MPa

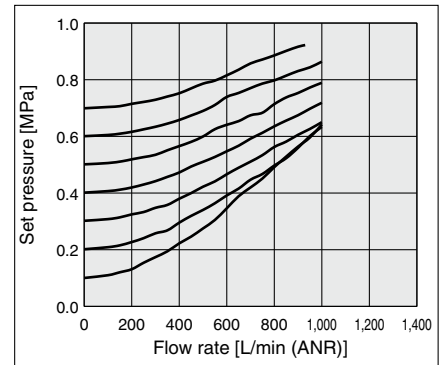

When the number of electro-pneumatic regulator stations is 3 or more, use a P, E port entry provided on "Both sides."

Excessive back pressure may damage the product.

Response Characteristics

(0 → 0.7 MPa/0 → 100%) Supply pressure: 1.0 MPa

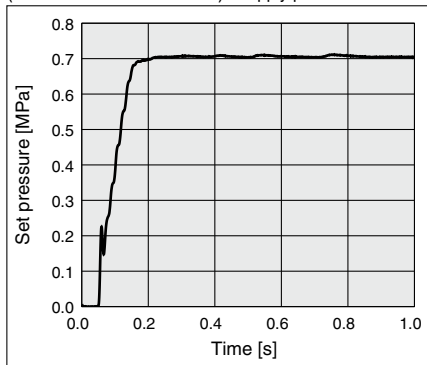

Power supply voltage: 24 VDC, Ambient temperature: 25 ±3°C, With no load on the outlet side

Response Characteristics

(0.175 → 0.525 MPa/25 → 75%) Supply pressure: 1.0 MPa

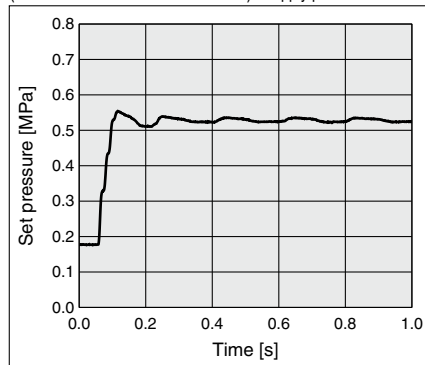

Power supply voltage: 24 VDC, Ambient temperature: 25 ±3°C, With no load on the outlet side

Response Characteristics

(0.315 → 0.385 MPa/45 → 55%) Supply pressure: 1.0 MPa

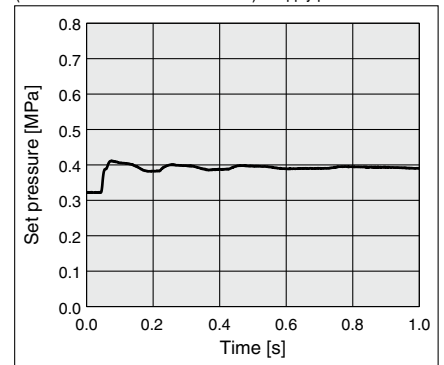

Power supply voltage: 24 VDC, Ambient temperature: 25 ±3°C, With no load on the outlet side

64-station Compatible Manifold

Plug-in Connector Connecting Base EX600

Type 10
Side Ported

JSY3000-P Series



Internal Pilot

How to Order Manifolds

* Only the dedicated SI unit can be mounted on the 64-station compatible manifold.

JJ5SY3-P 10S6 F [] [] - 24 B 1 - C8 []

Electro-pneumatic regulator integrated-type manifold identification symbol

① ② ③ ④ ⑤ ⑥ ⑦ ⑧

① SI unit

0	Without SI unit
F	PROFINET
E	EtherNet/IP™
D	EtherCAT

- * I/O unit cannot be mounted without SI unit.
- * SI units, I/O units, and valve plates are shipped together with the product but do not come assembled.

② End plate (SI unit)

Nil	Without SI unit	
4	M12 power supply connector, B-coded (EX600-ED2)	
5	7/8 inch power supply connector (EX600-ED3)	
7	M12 power supply connector	Pin arrangement 1 (EX600-ED4)
9	I/OUT, A-coded	Pin arrangement 2 (EX600-ED5)

- * When not selecting an SI unit, the symbol will be "nil."

③ I/O unit stations

Nil	None
1	1 station
:	:
8	8 stations

- * When not selecting an SI unit, the symbol will be "nil."
- * SI unit is not included in I/O unit stations.
- * When I/O unit is selected, it is shipped separately, and assembled by the customer. Refer to the attached operation manual for mounting.

④ Valve stations

Symbol	Stations	Note
04	4 stations	Double wiring*1
08	8 stations	
:	:	
60	60 stations	
64	64 stations	

- *1 Double wiring: 2-position single, 2-position double, 3-position, and 4-position valves can be used on all manifold stations. The use of a single solenoid will result in an unused control signal. This also includes the number of blanking plates.
- * For stations, only multiples of 4, from 4 stations to 64 stations, can be selected. The 4 boards inside the manifold are integrated.
- * The ITV is not included in the number of valve stations. Max. 4 sets are supported.

⑤ P, E port entry, SUP/EXH block assembly, Intermediate SUP/EXH block

P, E port entry	Internal pilot	Internal pilot, Built-in silencer	External pilot (Made to order)
U side (4 to 8 stations)	U	C	G
D side (4 to 8 stations)	D	E	H
Both sides (4 to 64 stations)	B	F	J

- * Ensure a match with the common specification of the valve to be used.
- * When not selecting an SI unit, the symbol will be "nil."

⑥ Number of intermediate SUP/EXH blocks, mounting position

Symbol	Qty.	Mounting position
0	0	—
1	1	Specify the mounting position on the manifold specification sheet.
:	:	
6	6	

- * A block can be installed for every 4 valve stations, but as a guideline, it is recommended that one be installed for every 8 to 12 stations.

⑦ Port size

Symbol	A, B port	P, E port
C4	Straight ø4	Straight ø10
C6	Straight ø6	
C8	Straight ø8	
CM*1	Straight port, mixed sizes	

- *1 Indicate the sizes on the manifold specification sheet for "CM."

⑧ Mounting and option

Symbol	Mounting
Nil	Direct mounting
D	DIN rail mounting (With DIN rail)
D0	DIN rail mounting (Without DIN rail)

- * Option "D" with DIN rail mounting is not compatible with the product without an SI unit.
- * Specify the DIN rail on the manifold specification sheet separately.

For details on the EX600 Integrated Type (For Output) Serial Transmission System, refer to the Web Catalog and the Operation Manual. For the part numbers of the SI units to be mounted, refer to page 8. Please download the Operation Manual via the SMC website.

JSY3000-P Series

How to Order Manifold Assembly

Example (JJ5SY3-P10S6F42-08B1-C8)

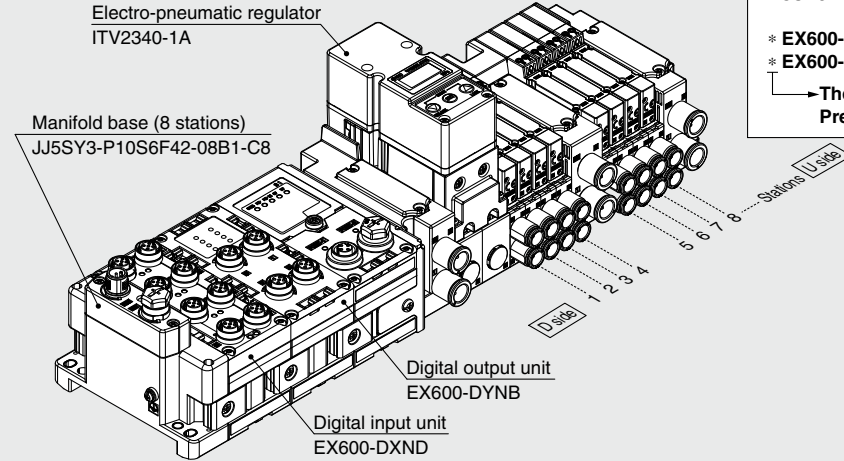

JJ5SY3-P10S6F42-08B1-C8

- * ITV2340-1A 1 set (Electro-pneumatic regulator, Valve supply type)
- * JSY3200-5U 8 sets (2-position double part no.)
- * JSY31M-40P-1A 1 set (SUP blocking disk, Mounted on the D side of the intermediate SUP/EXH block)
- * EX600-DXND 1 set I/O unit part number (Station 1)
- * EX600-DYNB 1 set I/O unit part number (Station 2)

→ The asterisk denotes the symbol for the assembly. Prefix it to the part numbers of the valve, etc.

· For the valve arrangement, the valve closest to the D side is considered the 1st station. The electro-pneumatic regulator is not included in the number of stations.

* Stations are only available in multiples of 4.

· Specify the mounting locations and quantities of valves, electro-pneumatic regulators, and other options on the manifold specification sheet separately.

Internal Pilot

How to Order Valves (With mounting screw)

Refer to the JSY series Web Catalog for valve specifications.

JSY3000 Series

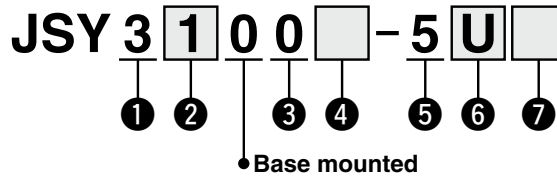

Made to Order
(For details, refer to the JSY series Web Catalog.)

1 Series

3	JSY3000
---	---------

3 Pilot valve exhaust method

0	Pilot valve individual exhaust
---	--------------------------------

4 Rated voltage

Symbol	Coil specifications
Nil	Standard
T	With power saving circuit (Continuous duty type)

* Be careful of the energizing time when the power-saving circuit is selected.

5 Rated voltage

5	24 VDC
---	--------

2 Type of actuation

1	2-position	Single
2		Double
3	3-position	Closed center
4		Exhaust center
5		Pressure center
A	4-position dual 3-port	N.C./N.C.
B		N.O./N.O.
C		N.C./N.O.

6 Light/surge voltage suppressor and common specification

Symbol	With light	Surge voltage suppressor	Common specification
U	•	•	Non-polar
NZ	•	•	Polar Negative common

* Only "NZ" type is available with a power saving circuit.

* When the non-polar common specification type is selected, take measures to prevent surge voltage. For details, refer to the Web Catalog.

7 Manual override

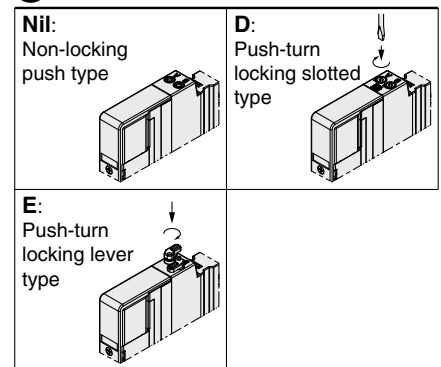

* **When ordering a valve individually, the base gasket is not included.**

Since the base gasket is attached to the manifold, please order the base gasket separately if it is needed for maintenance. Refer to the Web Catalog for base gasket and mounting screw part numbers.

⚠ Caution

If the product is to be continuously energized, please be sure to select the power-saving circuit (continuous duty type) specification.

* Refer to the "With power-saving circuit" section in the "Specific Product Precautions" of the plug-in type JSY series Web Catalog for details.

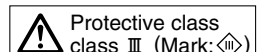

How to Order Electro-Pneumatic Regulators for Manifold (With mounting screw)

Valve supply type

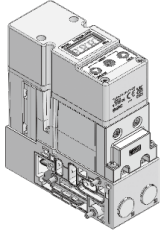

ITV2340-1□A

Direct output type

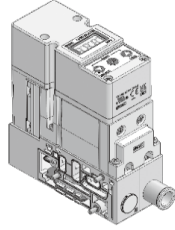

ITV2340-2□A

ITV2340-1□A

Output type

1	Valve supply type
2	Direct output type

Pressure display unit

Nil	MPa
3	bar
4*1	psi

*1 This product is for overseas use only according to the New Measurement Act. (The SI unit type is provided for use in Japan.)

Valve supply type

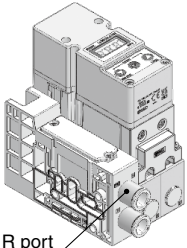

R port

ITV2340-1□M-□

Direct output type

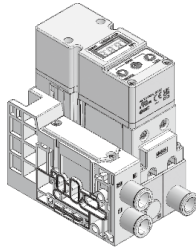

ITV2340-2□M-□

ITV2340-1□M-□

Output type

1	Valve supply type
2	Direct output type

Mounting and option

Nil	Direct mounting
D0	DIN rail mounting

Pressure display unit

Nil	MPa
3	bar
4*2	psi

Intermediate SUP/EXH block

M	P, R: ø10
S	P: ø10, R: Built-in silencer

*2 This product is for overseas use only according to the New Measurement Act. (The SI unit type is provided for use in Japan.)

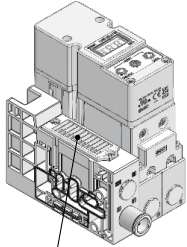

Silencer

ITV2340-1□S-□

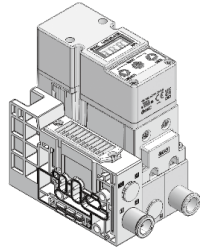

ITV2340-2□S-□

JSY3000-P Series

Type 10/Side Ported

Electro-Pneumatic Regulator D Side Mounting/EX600 (M12 connector)

Dimensions: JSY3000-P Series

JJ5SY3-P10S6 $\square \frac{4}{9} \square$ - Stations $\square \square \square$ - $\frac{C4}{C6}{C8}$ (D)

Refer to the operation manual for the detailed dimensions of each type.

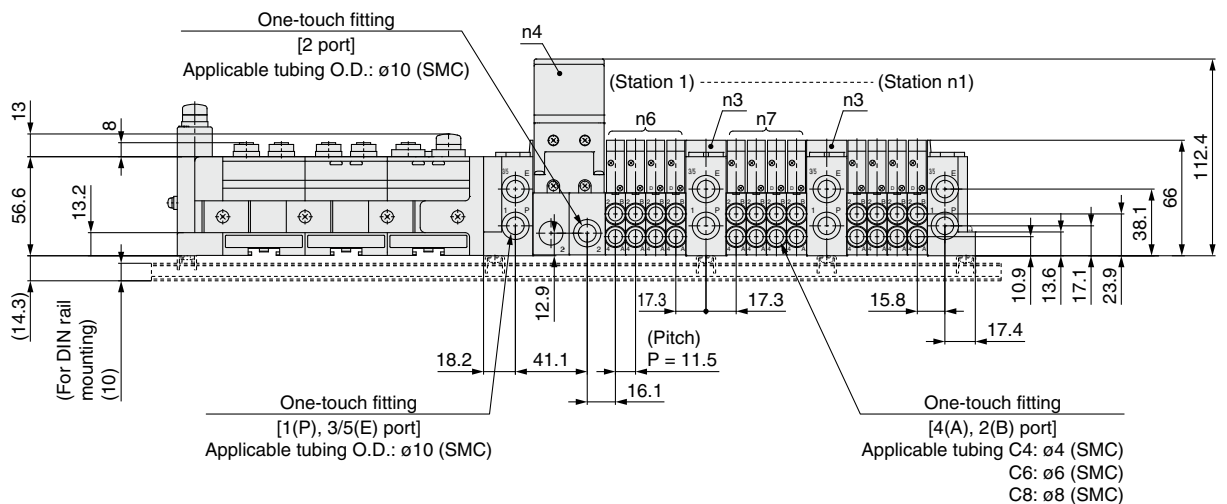
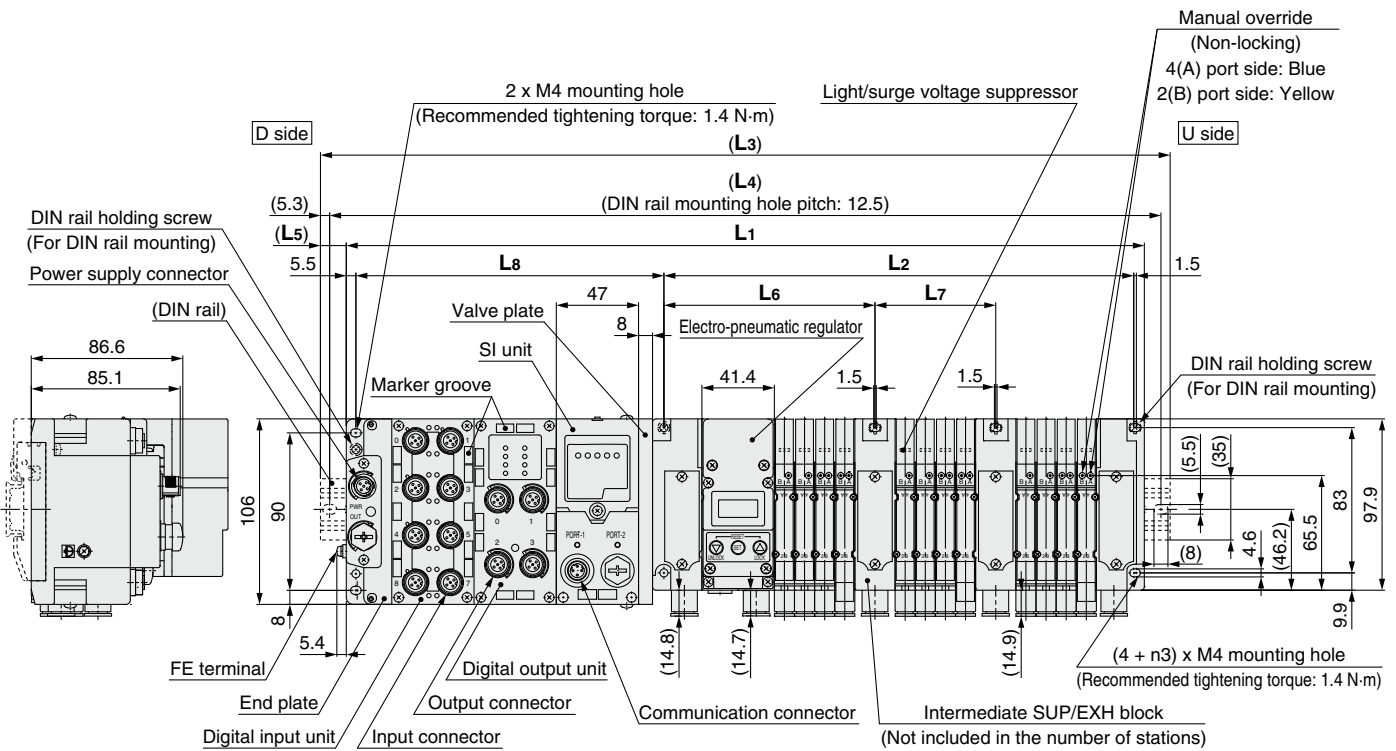

* These figures show the JJ5SY3-P10S6F72-12B2-C8.

Dimension calculation formulas

- L1: $11.5 \times n1 + 136.6 + 47 \times n2 + 23 \times n3 + 41.4 \times n4 + 64.4 \times n5$
- L2: $11.5 \times n1 + 43.1 + 23 \times n3 + 41.4 \times n4 + 64.4 \times n5$
- M: $L1/12.5 + 1$ (Decimal fractions are truncated.)
- L3: $12.5 \times M + 23$
- L4: $L3 - 10.5$
- L5: $(L3 - L1)/2$
- L6: $11.5 \times n6 + 41.4 \times n4 + 64.4 \times n5 + 33.2$
- L7: $11.5 \times n7 + 64.4 \times n5 + 23$
- L8: $47 \times n2 + 83.8$

- n1: Number of valve stations
- n2: Number of I/O units
- n3: Number of intermediate SUP/EXH blocks
- n4: Number of electro-pneumatic regulators (Without intermediate SUP/EXH block)
- n5: Number of electro-pneumatic regulators (With intermediate SUP/EXH block)
- n6: Number of valves from the D side to the first intermediate SUP/EXH block
- n7: Number of valves between the intermediate SUP/EXH blocks

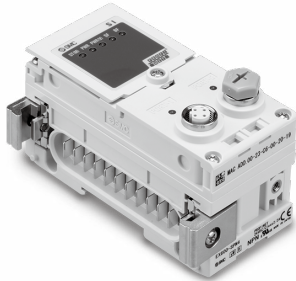

Specifications

SI Unit (For the Electro-Pneumatic Regulator/Manifold Type) PROFINET

Model		EX600-MPN1	
Communication	Protocol	PROFINET IO (Conformance Class C)	
	Communication speed	100 Mbps	
	Configuration file*1	GSDML file	
	Applicable function		Fast Start up
			MRP
		System Redundancy S2	
Internal current consumption (Power supply for control/input)		0.17 A or less	
Output	Electro-pneumatic regulator for manifold	Up to 4 units	
Standards		CE/UKCA marking, UL (CSA)	
Weight		310 g	
Environmental resistance	Operating temperature range	Operating: -10 to +50°C, Stored: -20 to +60°C	
	Operating humidity range	35 to 85% RH (No condensation)	
	Withstand voltage	500 VAC for 1 minute between external terminals and FE	
	Insulation resistance	500 VDC, 10 MΩ or more between external terminals and FE	

*1 The configuration file can be downloaded from the SMC website

SI Unit (For the Electro-Pneumatic Regulator/Manifold Type) EtherNet/IP™

Model		EX600-MEN1	
Communication	Protocol	EtherNet/IP™ (Conformance version: Composite19)	
	Communication speed	10/100 Mbps	
	Configuration file*1	EDS file	
	Applicable function		QuickConnect™
			DLR
		Web server	
Internal current consumption (Power supply for control/input)		0.17 A or less	
Output	Electro-pneumatic regulator for manifold	Up to 4 units	
Standards		CE/UKCA marking, UL (CSA)	
Weight		310 g	
Environmental resistance	Operating temperature range	Operating: -10 to +50°C, Stored: -20 to +60°C	
	Operating humidity range	35 to 85% RH (No condensation)	
	Withstand voltage	500 VAC for 1 minute between external terminals and FE	
	Insulation resistance	500 VDC, 10 MΩ or more between external terminals and FE	

*1 The configuration file can be downloaded from the SMC website.

SI Unit (For the Electro-Pneumatic Regulator/Manifold Type) EtherCAT

Model		EX600-MEC1
Communication	Protocol	EtherCAT (Conformance Test Record V2.4.0)
	Communication speed	100 Mbps
	Configuration file*1	XML file
	Applicable function	Web server
Internal current consumption (Power supply for control/input)		0.17 A or less
Output	Electro-pneumatic regulator for manifold	Up to 4 units
Standards		CE/UKCA marking, UL (CSA)
Weight		310 g
Environmental resistance	Operating temperature range	Operating: -10 to +50°C, Stored: -20 to +60°C
	Operating humidity range	35 to 85% RH (No condensation)
	Withstand voltage	500 VAC for 1 minute between external terminals and FE
	Insulation resistance	500 VDC, 10 MΩ or more between external terminals and FE

*1 The configuration file can be downloaded from the SMC website.

JSY3000-P Series

Dimensions

SI unit

EX600-MPN1

EX600-MEN1

EX600-MEC1

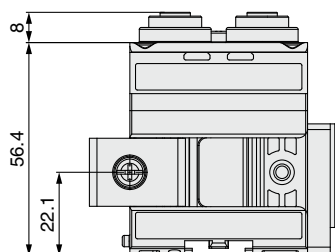
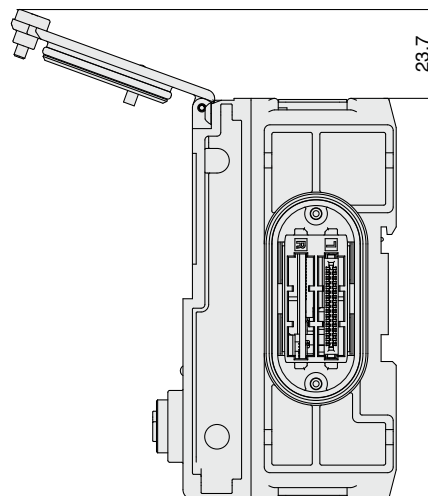
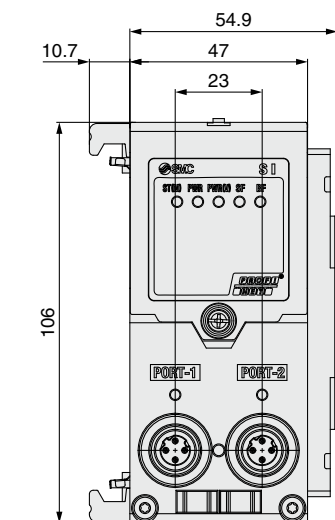

■Trademark

EtherNet/IP® is a registered trademark of ODVA, Inc.

EtherCAT® is registered trademark and patented technology, licensed by Beckhoff Automation GmbH, Germany.

QuickConnect™ is a trademark of ODVA

Manifold Parts Nos.

EX600 digital input unit

EX600 – DX **P** **B**

Input type

Symbol	Description
P	PNP
N	NPN

Number of inputs, open-circuit detection, and connector

Symbol	Number of inputs	Open-circuit detection	Connector
B	8	No	M12 connector (5 pins) 4 pcs.
C	8	No	M8 connector (3 pins) 8 pcs.
C1	8	Yes	M8 connector (3 pins) 8 pcs.
D	16	No	M12 connector (5 pins) 8 pcs.
E	16	No	D-sub connector (25 pins)
F	16	No	Spring type terminal block (32 pins)

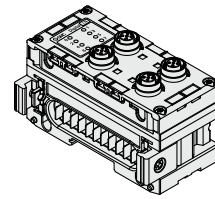

EX600 digital output unit

EX600 – DY **P** **B**

Output type

Symbol	Description
P	PNP
N	NPN

Number of outputs and connector

Symbol	Number of outputs	Connector
B	8	M12 connector (5 pins) 4 pcs.
E	16	D-sub connector (25 pins)
F	16	Spring type terminal block (32 pins)

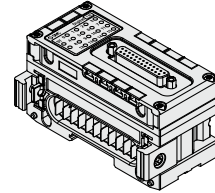

EX600 digital input/output unit

EX600 – DM **P** **E**

Input/Output type

Symbol	Description
P	PNP
N	NPN

Number of inputs/outputs and connector

Symbol	Number of inputs	Number of outputs	Connector
E	8	8	D-sub connector (25 pins)
F	8	8	Spring type terminal block (32 pins)

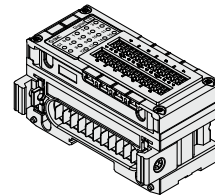

EX600 analog input/output unit

EX600 – AX **A**

Analog input/output

Symbol	Description
AX	Analog input
AY	Analog output

Number of channels and connector

Symbol	Number of channels	Connector
A	2 channels	M12 connector (5 pins) 2 pcs.

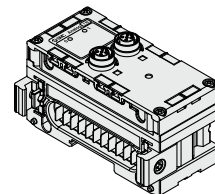

EX600 analog input/output unit

EX600 – AM **B**

Analog input/output

Number of input/output channels and connector

Symbol	Number of input channels	Number of output channels	Connector
B	2 channels	2 channels	M12 connector (5 pins) 4 pcs.

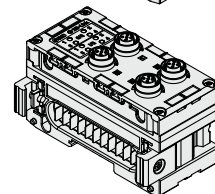
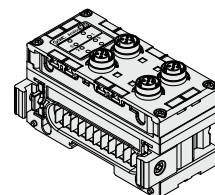

EX600 IO-Link unit

EX600 – L **A** **B** 1

Port specification

Symbol	Description
A	Port class A
B	Port class B

Number of ports and connector

Symbol	Number of ports	Connector
B	4 ports	M12 connector (5 pins) 4 pcs.

Clamp bracket for EX600

EX600 – ZMA3

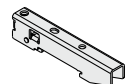

Enclosed parts

Round head screw with washer (M4 x 20) 1 pc.
P-tight screw (4 x 14) 2 pcs.

EX600 end plate

EX600 – ED **2** - □

Power connector

Symbol	Connector
2	M12 power supply connector, B-coded
3	7/8 inch power supply connector
4	M12 power supply connector IN/OUT, A-coded, Pin arrangement 1
5	M12 power supply connector IN/OUT, A-coded, Pin arrangement 2

* The pin layout for the "4" and "5" pin connectors is different.

Mounting

Symbol	Description
Nil	Without DIN rail mounting bracket
3	With DIN rail mounting bracket

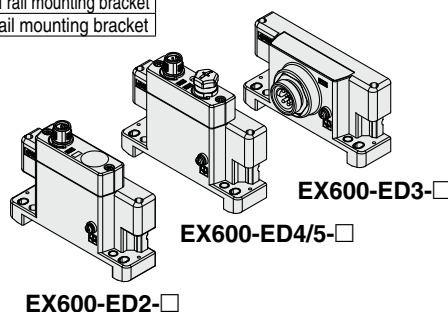

Valve plate

EX600 – ZMV3

* With mounting screws (2 pcs. of M4 x 6 and 2 pcs. of M3 x 8)

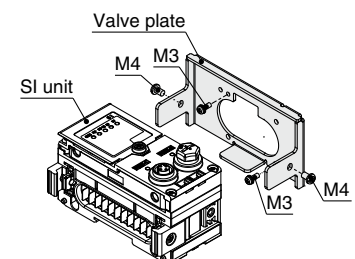

* For details, refer to the **Web Catalog** of the Fieldbus system (for input/output) EX600 series.

JSY3000-P Series Manifold Options

⚠ Caution Tightening torque for mounting screw
M2: 0.16 N·m (JSY3000)

* Refer to the **Web Catalog** for dimensions.

■ Blanking plate

[With two mounting screws]

Used when valve additions are expected or for maintenance

JSY31M – 26P – 1A

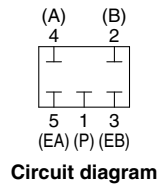
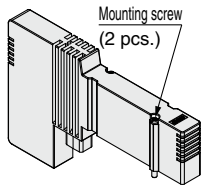

JSY31M-26P-1A

■ Individual SUP spacer

[With a connector gasket, a base gasket, and two mounting screws]

When the same manifold is to be used for different pressures, an individual SUP spacer assembly can be used to act as a supply port for different pressures.

JSY31M – 38 P – 1A – C6

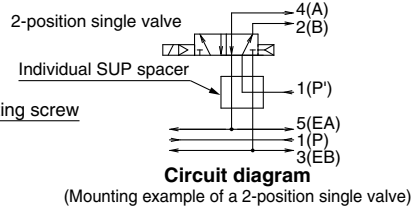
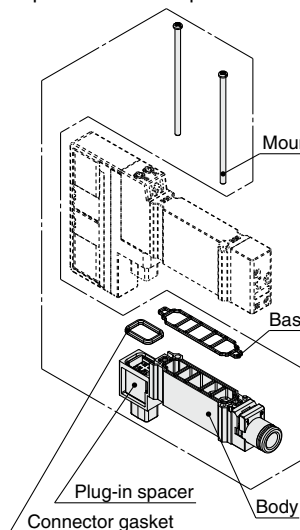

Mounting screw part number
(For repairs)
JSY3000: JSY31V-23-2A (2 pcs.)

● Port size
(One-touch fitting)

● Spacer type

38	Individual SUP spacer
39	Individual EXH spacer

■ Individual EXH spacer

[With a connector gasket, a base gasket, and two mounting screws]

When valve exhaust affects other stations due to the circuit configuration, this spacer can be used for individual valve exhaust.

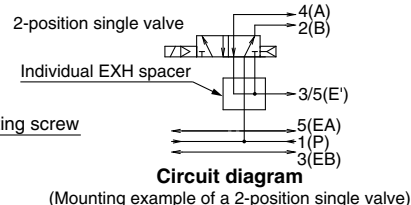
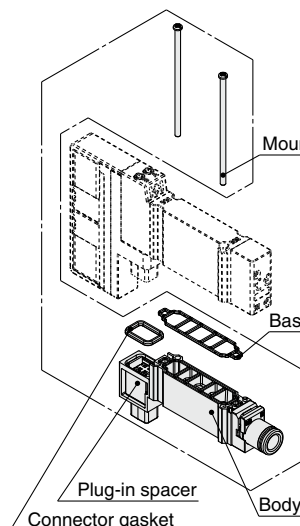

Mounting screw part number
(For repairs)
JSY3000: JSY31V-23-2A (2 pcs.)

■ SUP/EXH blocking disk

[SUP blocking disk]

Inserting an SUP blocking disk in the pressure supply passage of a manifold valve can allow for the use of 2 different pressures (high and low) in 1 manifold.

[EXH blocking disk]

Inserting an EXH blocking disk in the exhaust passage of a manifold valve can separate the exhaust from the valve so it does not affect the other valves. It can also be used in positive pressure and vacuum pressure mixed manifolds. (2 pieces are required to block both the EA and EB sides of the EXH.)

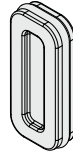

Series	SUP blocking disk	EXH blocking disk
JSY3000	JSY31M-40P-1A	JSY31M-40P-2A

■ Labels for blocking disks

These labels can be used to indicate and confirm where on the manifold the SUP/EXH blocking disk assemblies were inserted. (3 labels of each)

SUP/EXH blocking disk label

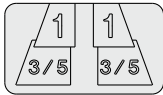

SUP blocking disk label

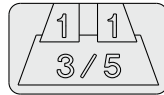

EXH blocking disk label

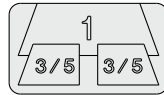

Series	Part no.
JSY3000	SJ3000-155-1A

⚠ Caution

The manifold base cannot be disassembled by the customer. Specify the mounting location of the intermediate SUP/EXH block assembly on the manifold specification sheet.

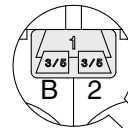

* If the blocking disk is ordered using the manifold specification sheet and ordered at the same time as the manifold, the position where the blocking disk is inserted will be labeled and shipped out.

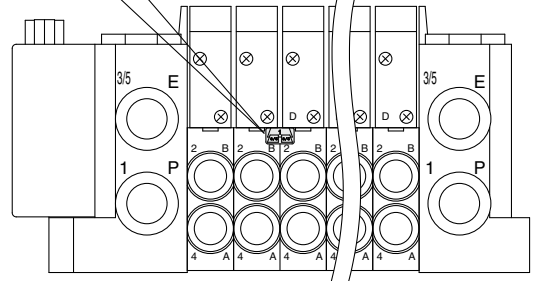

■ Silencer

(One-touch fitting connection type)

This silencer can be mounted to the 3/5 (E: EXH) port of the manifold in one step.

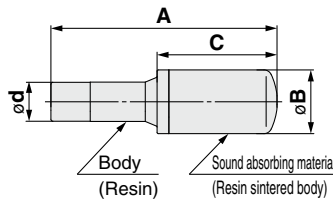

* Shipped together with the product

Series (ød)	Model	Effective area	A	B	C
For JSY3000 (ø10)	AN20-C10	30 mm ²	57.5	16.5	30.5

■ Intermediate SUP/EXH Block Assembly

JSY31M - 125P - 1A - **C10**

Pilot, Silencer type

Symbol	Pilot type		Built-in silencer
	Internal	External (Made to Order)	
Nil	●	—	—
S	●	—	●
R	—	●	—

Mounting

Nil	Direct mounting
D0	DIN rail mounting (Without DIN rail)

P, E port size (One-touch fitting)

Symbol	P, E port	JSY3000
C10	ø10 One-touch fitting	●

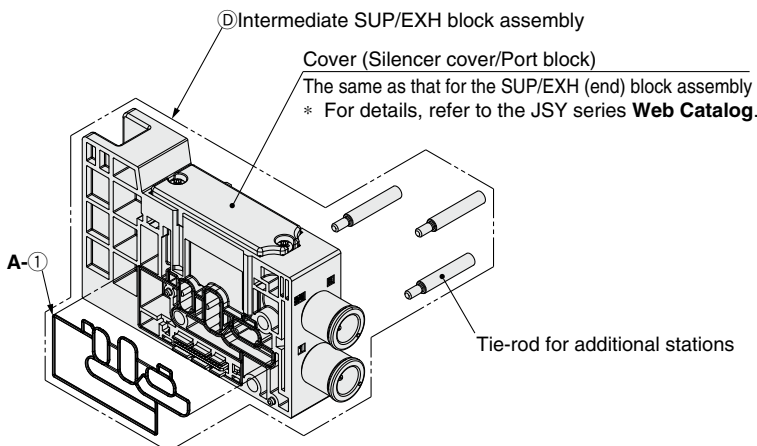

Intermediate SUP/EXH block assembly accessories and the number of accessories

Accessories	Quantity
Tie-rod for additional stations	3 pcs.
A-① Manifold block gasket	1 pc.

* Gasket is mounted.

Clamp bracket

Series	Part no.
JSY3000	SY30M-15-1A

⚠ Caution

The manifold base cannot be disassembled by the customer. Specify the mounting location of the intermediate SUP/EXH block assembly on the manifold specification sheet.

Safety Instructions

These safety instructions are intended to prevent hazardous situations and/or equipment damage. These instructions indicate the level of potential hazard with the labels of “**Caution**,” “**Warning**” or “**Danger**.” They are all important notes for safety and must be followed in addition to International Standards (ISO/IEC)*¹⁾, and other safety regulations.

 **Danger :** **Danger** indicates a hazard with a high level of risk which, if not avoided, will result in death or serious injury.

 **Warning:** **Warning** indicates a hazard with a medium level of risk which, if not avoided, could result in death or serious injury.

 **Caution:** **Caution** indicates a hazard with a low level of risk which, if not avoided, could result in minor or moderate injury.

*1) ISO 4414: Pneumatic fluid power - General rules and safety requirements for systems and their components
ISO 4413: Hydraulic fluid power - General rules and safety requirements for systems and their components
IEC 60204-1: Safety of machinery - Electrical equipment of machines - Part 1: General requirements
ISO 10218-1: Robots and robotic devices - Safety requirements for industrial robots - Part 1: Robots etc.

Warning

1. The compatibility of the product is the responsibility of the person who designs the equipment or decides its specifications.

Since the product specified here is used under various operating conditions, its compatibility with specific equipment must be decided by the person who designs the equipment or decides its specifications based on necessary analysis and test results. The expected performance and safety assurance of the equipment will be the responsibility of the person who has determined its compatibility with the product. This person should also continuously review all specifications of the product referring to its latest catalog information, with a view to giving due consideration to any possibility of equipment failure when configuring the equipment.

2. Only personnel with appropriate training should operate machinery and equipment.

The product specified here may become unsafe if handled incorrectly. The assembly, operation and maintenance of machines or equipment including our products must be performed by an operator who is appropriately trained and experienced.

3. Do not service or attempt to remove product and machinery/equipment until safety is confirmed.

1. The inspection and maintenance of machinery/equipment should only be performed after measures to prevent falling or runaway of the driven objects have been confirmed.
2. When the product is to be removed, confirm that the safety measures as mentioned above are implemented and the power from any appropriate source is cut, and read and understand the specific product precautions of all relevant products carefully.
3. Before machinery/equipment is restarted, take measures to prevent unexpected operation and malfunction.

4. Our products cannot be used beyond their specifications. Our products are not developed, designed, and manufactured to be used under the following conditions or environments. Use under such conditions or environments is not covered.

1. Conditions and environments outside of the given specifications, or use outdoors or in a place exposed to direct sunlight.
2. Use for nuclear power, railways, aviation, space equipment, ships, vehicles, military application, equipment affecting human life, body, and property, fuel equipment, entertainment equipment, emergency shut-off circuits, press clutches, brake circuits, safety equipment, etc., and use for applications that do not conform to standard specifications such as catalogs and operation manuals.
3. Use for interlock circuits, except for use with double interlock such as installing a mechanical protection function in case of failure. Please periodically inspect the product to confirm that the product is operating properly.

Caution

We develop, design, and manufacture our products to be used for automatic control equipment, and provide them for peaceful use in manufacturing industries.

Use in non-manufacturing industries is not covered.

Products we manufacture and sell cannot be used for the purpose of transactions or certification specified in the Measurement Act.

The new Measurement Act prohibits use of any unit other than SI units in Japan.

Limited warranty and Disclaimer/ Compliance Requirements

The product used is subject to the following “Limited warranty and Disclaimer” and “Compliance Requirements”.

Read and accept them before using the product.

Limited warranty and Disclaimer

1. The warranty period of the product is 1 year in service or 1.5 years after the product is delivered, whichever is first.*²⁾
Also, the product may have specified durability, running distance or replacement parts. Please consult your nearest sales branch.
2. For any failure or damage reported within the warranty period which is clearly our responsibility, a replacement product or necessary parts will be provided.
This limited warranty applies only to our product independently, and not to any other damage incurred due to the failure of the product.
3. Prior to using SMC products, please read and understand the warranty terms and disclaimers noted in the specified catalog for the particular products.

*²⁾ **Vacuum pads are excluded from this 1 year warranty.**

A vacuum pad is a consumable part, so it is warranted for a year after it is delivered.

Also, even within the warranty period, the wear of a product due to the use of the vacuum pad or failure due to the deterioration of rubber material are not covered by the limited warranty.

Compliance Requirements

1. The use of SMC products with production equipment for the manufacture of weapons of mass destruction (WMD) or any other weapon is strictly prohibited.
2. The exports of SMC products or technology from one country to another are governed by the relevant security laws and regulations of the countries involved in the transaction. Prior to the shipment of a SMC product to another country, assure that all local rules governing that export are known and followed.

Safety Instructions

Be sure to read the “Handling Precautions for SMC Products” (M-E03-3) and “Operation Manual” before use.

SMC Corporation